



DOMOTIX
READY



APP
CONTROL



WIRELESS
REMOTE



CORDED
OPERATION



MANUAL
OPERATION

FOREST DECORATIVE ROD Series

Elegant and trendy rod systems. Available as manual, chain and motorised system.

CRS®
CRS® Deco
CRS® Corded
MRS® Motorised

THE WORLD
BEHIND
YOUR
CURTAINS



FOREST CURTAIN ROD SYSTEM - CRS®



PRODUCT INFORMATION

- Elegant and trendy hand drawn channel rod system
- Curtain rod fitted with curtain carriers
- Available in two dimensions: 20 mm (0.8") and 28 mm (1.1")
- Bendable, both with an inside and outside corner (except for Chrome)
- Available colours: White-pc, Anthracite-pc, Chrome, Inox-an, Stone Grey-pc, Gold-an, Taupe-pc, Antique-pc and Black-pc
- The brackets and endcaps are available in matching colours
- Wide range of decorative finials offering great variety of design options
- Possibility to use without a finial for inside frame fix
- Length: 5.80 m (19")
- Rod quality: high-grade aluminium, powder coated or anodised
- Easy and quick assembly
- Forest Easyfold System (FES) for wave pleat also applicable on CRS

PROFILE

- Shown actual size 1:1
- Aluminium Extrusion
- Weight 20 mm (0.8"): 320 gram per meter
- Weight 28 mm (1.1"): 460 gram per meter
- Dimensions: 20 mm (0.8") and 28 mm (1.1")

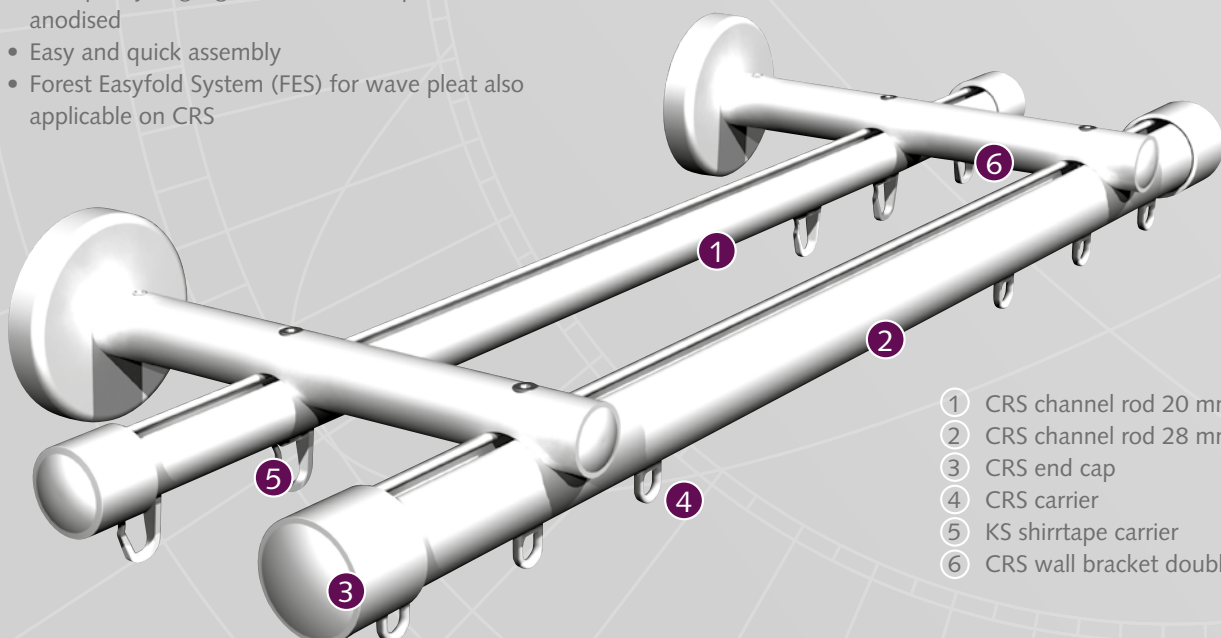
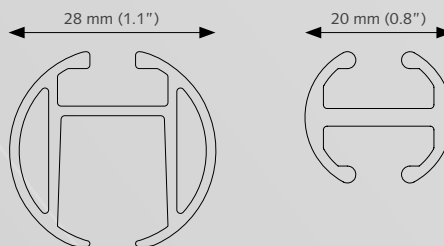

- 1 CRS channel rod 20 mm (0,8")
- 2 CRS channel rod 28 mm (1,1")
- 3 CRS end cap
- 4 CRS carrier
- 5 KS shirrtape carrier
- 6 CRS wall bracket double



APPLICATIONS

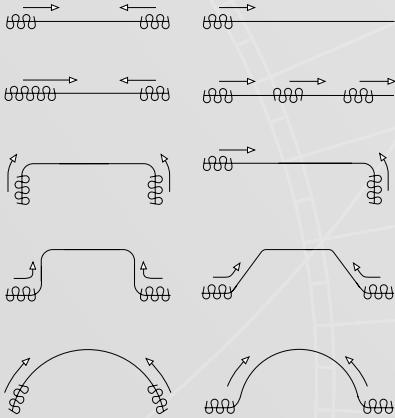

BENDING / CURVING

The 20 mm (0,8") rod can be bent and reverse bent using a radius of 10 cm (4"); the 28 mm (1,1") rod can be bent and reverse bent by using a radius of 20 cm (8").



FOR USE IN

Domestic and / or project market, or at any location where a high quality, elegant and manually operated channel rod system is requested.

MOUNTING BRACKETS

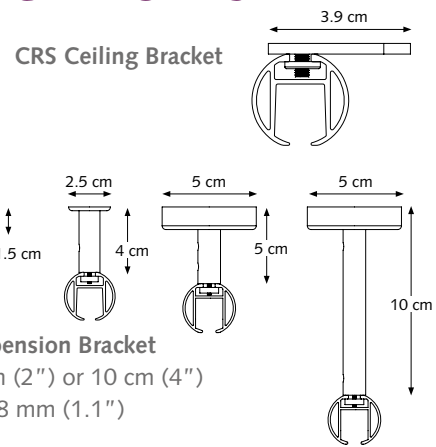

CRS Wall Bracket, single

8 cm*(3.1") Ø 20 (0.8") or 28 mm (1.1")
 12 cm**(4.7") Ø 20 (0.8") or 28 mm (1.1")
 16 cm**(6.3") Ø 20 (0.8")
 or 28 mm (1.1")

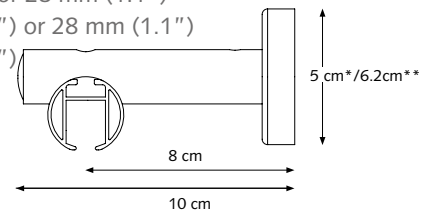

CRS Wall Bracket, double

16 cm (6.3") Ø 20 mm (0.8")
 16 cm (6.3") Ø 28 mm (1.1")
 20 cm (7.87") Ø 28 mm (1.1")

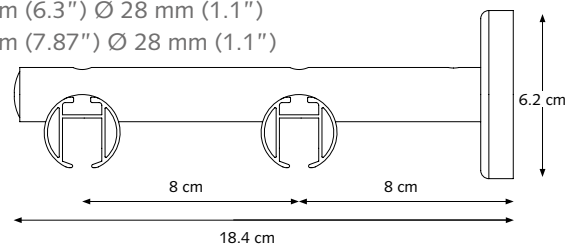

CRS Wall Bracket, double

16 cm (6.3") Ø 20/28 mm (0.8/1.1")

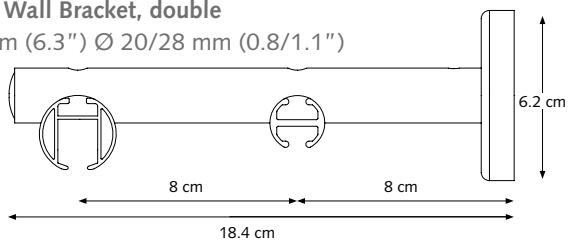

CRS Adjustable Wall Bracket

8 cm (3.1") Ø 20 (0.8") or 28 mm (1.1"), adjustable to 9,5 cm (3.7"). A = 8.9 (3.5") / B = 8 (3.1") < > 9.5 (3.7") / D = 3.75 (1.5") / E = 5.95 cm (2.3")

12 cm (4.7") Ø 20 (0.8") or 28 mm (1.1"), adjustable to 13.5 cm (5.3"). A = 12.9 (5.1") / B = 12 (4.7") < > 13.5 (5.3") / D = 3.75 (1.5") / E = 5.95 cm (2.3")

16 cm (6.3") Ø 20 (0.8") or 28 mm (1.1"), adjustable to 21 cm (8.3"). A = 18.9 (7.4") / B = 7.5 (3.0") < > 10.5 (4.1") / C = 9 (3.5") < > 10.5 (4.1") / D = 3.75 (1.5") / E = 5.95 cm (2.3")

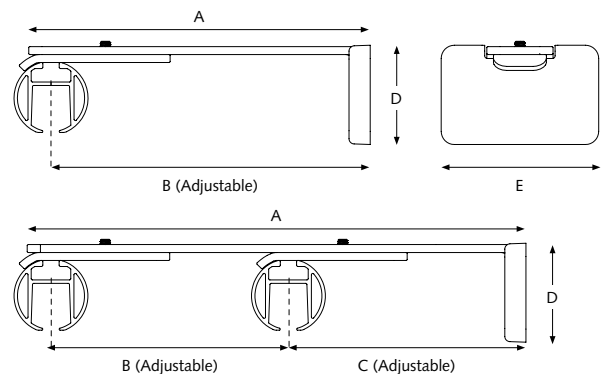

FOREST CRS® Deco



PRODUCT INFORMATION

- Elegant and decorative hand drawn channel rod system
- Curtain rod fitted with eyelets and rings
- Equipped with special inlay for smooth operation and noise reduction
- Available in two dimensions: 20 mm (0.8") and 28 mm (1.1")
- Available in 5 colours: Anthracite-pc, Chrome, Inox-an, Taupe-pc, Antique-pc
- The brackets and decorative endcaps are available in matching colours
- Wide range of decorative finials offering great variety of design options
- Possibility to use without a finial for inside frame fix
- Length: 5.80 m (19")
- Rod quality: high-grade aluminium, powder coated or anodised
- Easy and quick assembly
- The CRS Deco cannot be bent

PROFILE

- Shown actual size 1:1
- Aluminium Extrusion
- Track Ø 20 mm (0.8"): Maximum 3 kilograms at a support distance of 1.5 meters.
- Track Ø 28 mm (1.1"): Up to 4 kilograms at a support distance of 2.5 meters.
- Dimensions: 20 mm (0.8") and 28 mm (1.1")

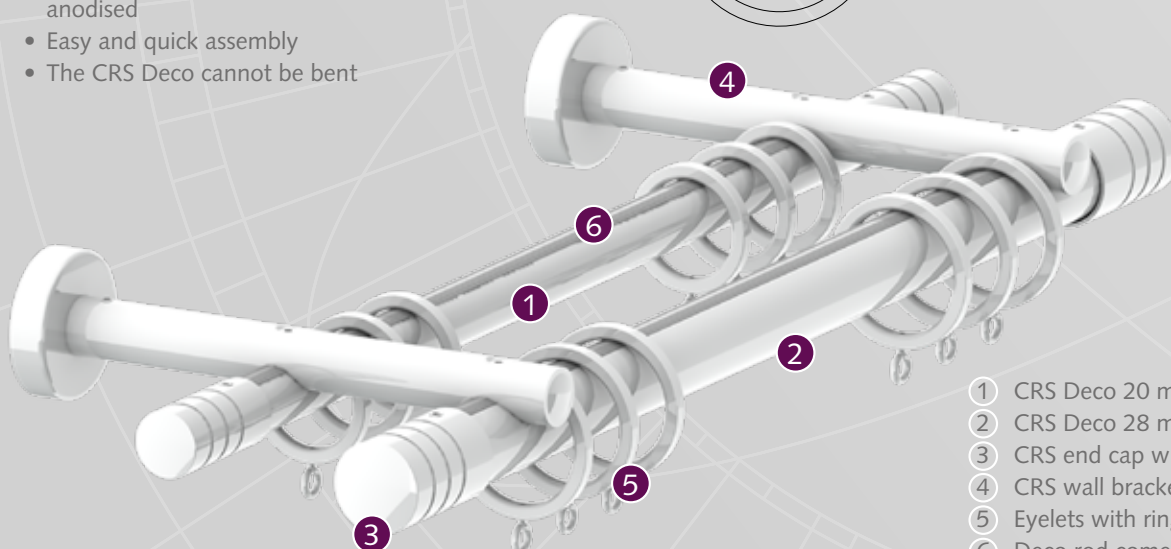
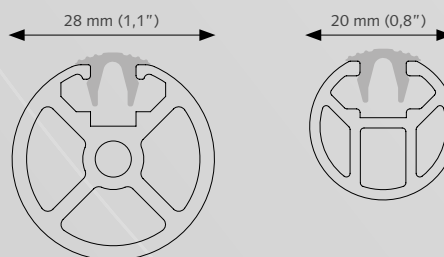

- 1 CRS Deco 20 mm (0,8")
- 2 CRS Deco 28 mm (1,1")
- 3 CRS end cap with 3 grooves
- 4 CRS wall bracket double
- 5 Eyelets with rings
- 6 Deco rod comes with a special inlay on top.



MOUNTING BRACKETS

CRS Ceiling Suspension Bracket

4 cm (1.6"), 5 cm (2") or 10 cm (4")
20 mm (0.8")/ 28 mm (1.1")

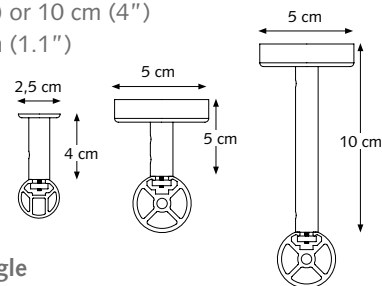

CRS Wall Bracket, single

8 cm* (3.1") Ø 20 (0.8") or 28 mm (1.1")
12 cm** (4.7") Ø 20 (0.8") or 28 mm (1.1")
16 cm** (6.3") Ø 20 (0.8") or 28 mm (1.1")

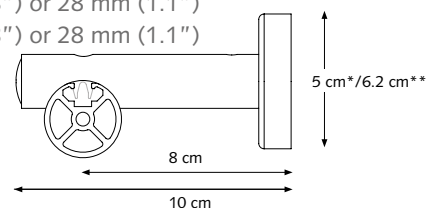

CRS Wall Bracket, double

16 cm (6.3") Ø 20 mm (0.8")
16 cm (6.3") Ø 28 mm (1.1")
20 cm (7.87") Ø 28 mm (1.1")

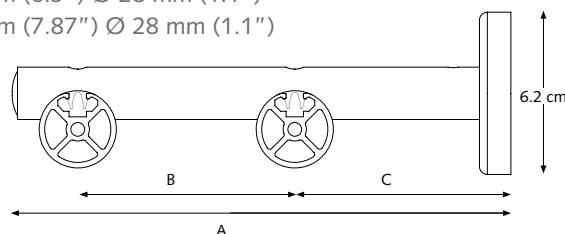

CRS Wall Bracket, double

16 cm (6.3") Ø 20/28 mm (0.8/1.1")

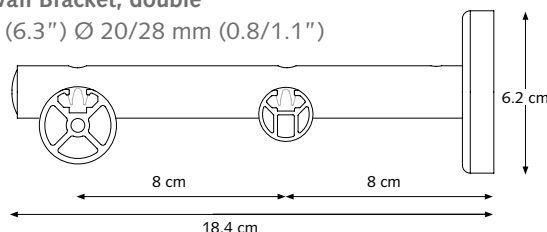

CRS Adjustable Wall Bracket

8 cm (3.1") Ø 20 (0.8") or 28 mm (1.1"), adjustable to 9.5 cm (3.7"). A = 8.9 (3.5") / B = 8 (3.1") < > 9.5 (3.7") / D = 3.75 (1.5") / E = 5.95 cm (2.3")

12 cm (4.7") Ø 20 (0.8") or 28 mm (1.1"), adjustable to 13.5 cm (5.3"). A = 12.9 (5.1") / B = 12 (4.7") < > 13.5 (5.3") / D = 3.75 (1.5") / E = 5.95 cm (2.3")

16 cm (6.3") Ø 20 (0.8") or 28 mm (1.1"), adjustable to 21 cm (8.3"). A = 18.9 (7.4") / B = 7.5 (3.0") < > 10.5 (4.1") / C = 9 (3.5") < > 10.5 (4.1") / D = 3.75 (1.5") / E = 5.95 cm (2.3")

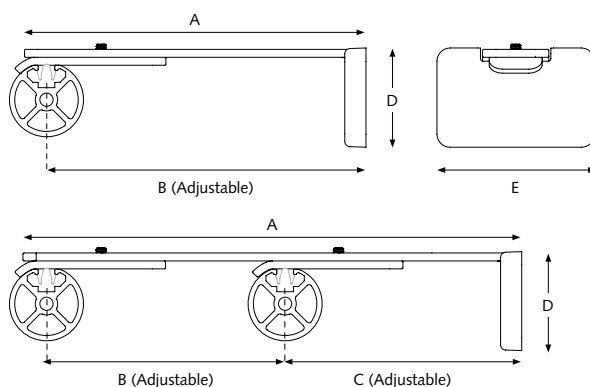

APPLICATIONS



SMOOTH AND SILENT OPERATION



Equipped with special inlay on top of rod for smooth operation and noise reduction.

FOR USE IN

Domestic and / or project market, or at any location where a high quality, elegant and manually operated channel rod system is requested.

SELECT YOUR FINIAL

Our large range of decorative finials offers you a great variety of design options. But is also possible to use without finial.



FOREST CRS® Corded



PRODUCT INFORMATION

- Elegant and trendy cord-operated channel rod system
- Curtain rod fitted with curtain carriers
- Available dimension: 28 mm (1.1")
- Bendable, both with an inside and outside corner (except for Chrome)
- Available in colours: White-pc, Inox-an, Stone Grey-pc, Antique-pc, Anthracite-pc, Taupe-pc, Chrome & Gold-an
- The brackets and endcaps are available in matching colours
- Wide range of decorative finials offering great variety of design options
- Length: 5,80 m (19")
- Rod quality: high-grade aluminium, powder coated or anodised
- Easy and quick assembly
- Forest Easyfold System (FES) for wave pleat also applicable on CRS Corded
- Dual cord available

PROFILE

- Shown actual size 1:1
- Weight per meter: 8 kg and max weight load: 50 kg
- Aluminium extrusion
- Dimension: 28 mm (1.1")

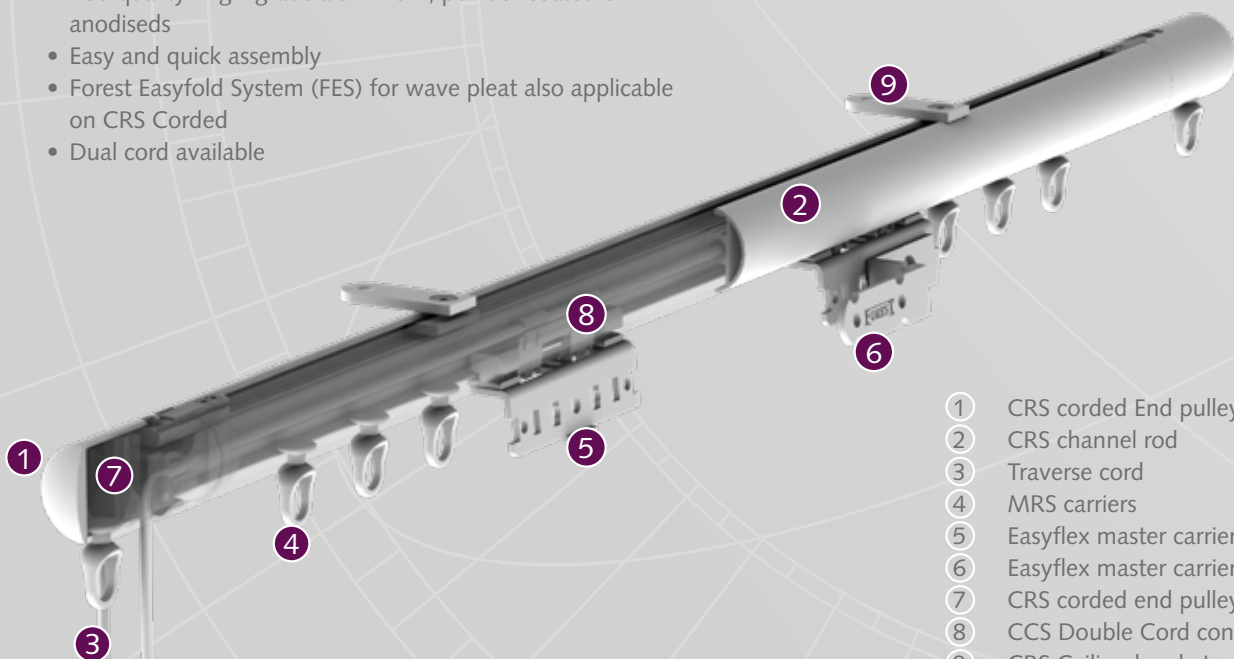
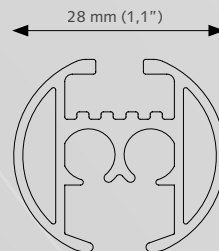

- 1 CRS corded End pulley short
- 2 CRS channel rod
- 3 Traverse cord
- 4 MRS carriers
- 5 Easyflex master carrier 90° left
- 6 Easyflex master carrier 90° right
- 7 CRS corded end pulley base
- 8 CCS Double Cord connector
- 9 CRS Ceiling bracket with hole



MOUNTING BRACKETS

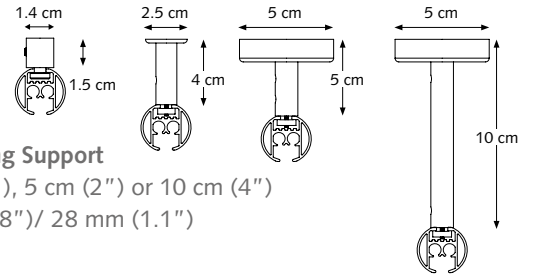
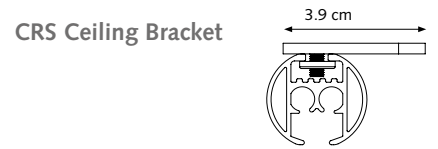

CRS Ceiling Support

4 cm (1.6"), 5 cm (2") or 10 cm (4")
20 mm (0.8")/ 28 mm (1.1")

CRS Wall Bracket, single

8 cm* (3.1")* Ø 28 mm
12 cm (4.7")** Ø 28 mm
16 cm (6.3")** Ø 28 mm

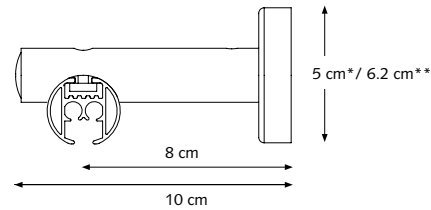

CRS Wall Bracket, double

16 cm (6.3") Ø 20 mm (0.8")
16 cm (6.3") Ø 28 mm (1.1")
20 cm (7.87") Ø 28 mm (1.1")

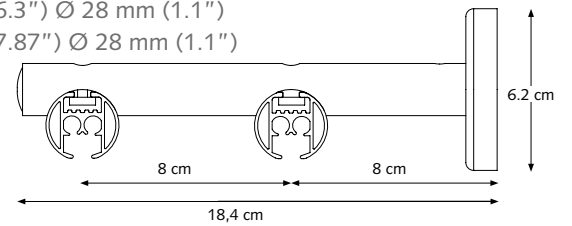

CRS Wall Bracket, double

16 cm (6.3") Ø 20 mm (0.8") (manual) /
28 mm (1.1") (corded)

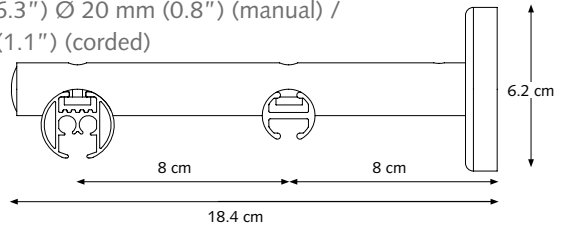

CRS Adjustable Wall Bracket

8 cm (3.1") Ø 20 (0.8") or 28 mm (1.1"), adjustable to
9.5 cm (3.7"). A = 8.9 (3.5") / B = 8 (3.1") <> 9.5 (3.7") /
D = 3.75 (1.5") / E = 5.95 cm (2.3")

12 cm (4.7") Ø 20 (0.8") or 28 mm (1.1"), adjustable to
13.5 cm (5.3"). A = 12.9 (5.1") / B = 12 (4.7") <> 13.5 (5.3")
/ D = 3.75 (1.5") / E = 5.95 cm (2.3")

16 cm (6.3") Ø 20 (0.8") or 28 mm (1.1"), adjustable to
21 cm (8.3"). A = 18.9 (7.4") / B = 7.5 (3.0") <> 10.5 (4.1")
/ C = 9 (3.5") <> 10.5 (4.1") / D = 3.75 (1.5") / E = 5.95 cm (2.3")

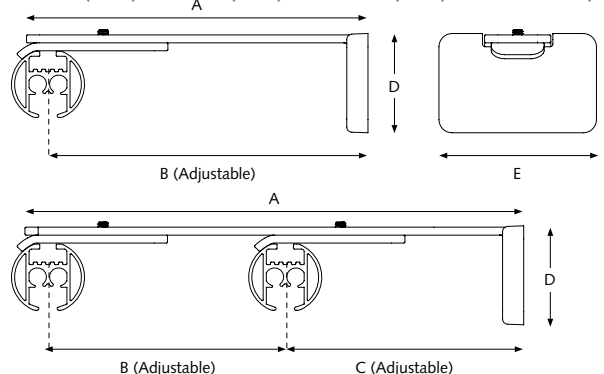

APPLICATIONS



Cross-Section Channel Rod with
cord connectors and carriers.

BENDING / CURVING

The 28 mm (1.1") rod can be curved and reverse curved
by using a radius of 20 cm (8").



FOR USE IN

Domestic and / or contract market, or at any location
where a high quality, elegant and corded operated
channel rod system is required.

FOREST MOTORISED ROD SYSTEM - MRS®



PRODUCT INFORMATION

- Comfortable and luxurious motorised channel rod system
- Curtain rod fitted with curtain carriers
- Two types of motors available:
 - 24 Volt Forest Shuttle with touch impulse
 - 230 Volt FMS with 30, 45 or 60 Watt
- Available dimension: 28 mm (1.1")
- Available colours: White-pc, Anthracite-pc, Chrome*, Inox-an, Stone Grey-pc, Gold-an, Taupe-pc, Antique-pc
- The brackets and endcaps are available in matching colours
- Wide range of decorative finials offering great variety of design options
- Length: 5.80 m (19")
- Rod quality: high-grade aluminium, powder coated or anodised
- Easy-running return pulley
- Smooth and silent operation through Kevlar reinforcement of the transport belt
- Long life-span
- Improved motor pulley: creates a perfectly even pleat across the motor
- Improved return pulley: allows the curtain to travel all way to the end
- Both new motor pulley and return pulley can be reversibly installed, left or right
- Overlap carriers guarantees a complete closing of the curtains
- Forest Wave System for wave pleat also applicable on MRS
- Unique warranty: 10 year
- The MRS cannot be bent



3

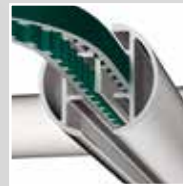

6



7

- 1 MRS channel rod
- 2 MRS end cap
- 3 MRS motor pulley equipped with high-quality ball bearings
- 4 Square Easy wave carrier
- 5 Wave adjustable master carrier
- 6 Kevlar transport belt
- 7 Easy running return pulley

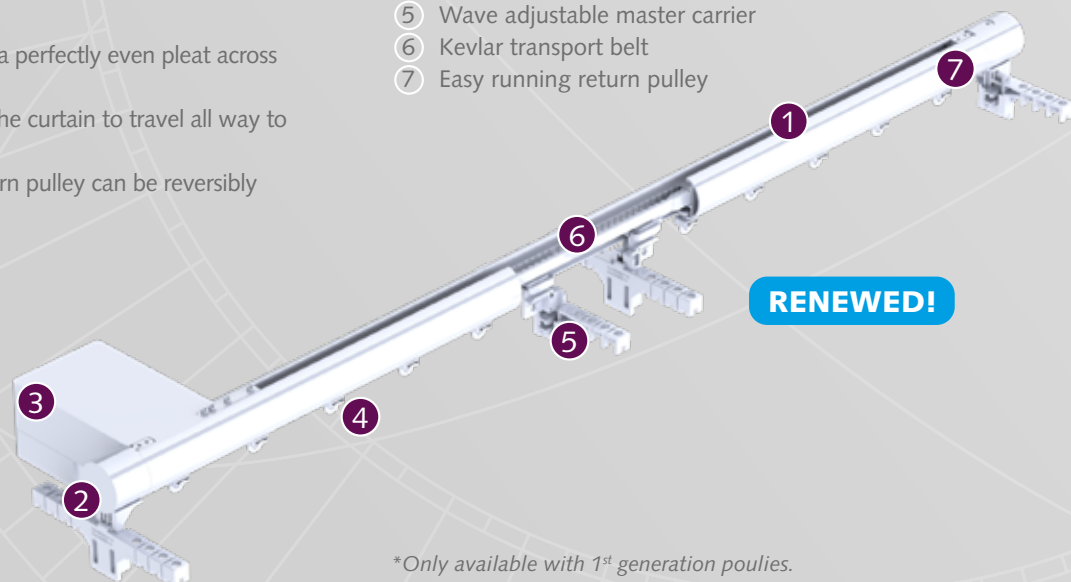

*Only available with 1st generation pulleys.



PROFILE

- Shown actual size 1:1
- Weight 480 gr/mtr
- Aluminium Extrusion
- Dimension: 28 mm (1.1")

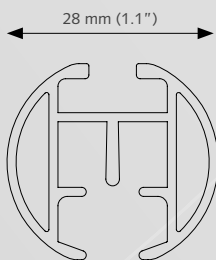

APPLICATIONS

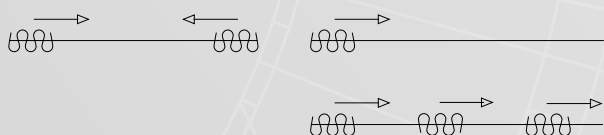

FOR USE IN

Domestic and / or contract market, or at any location where a high quality, elegant and motorised operated channel rod system is required.

MOUNTING BRACKETS

MRS Ceiling Bracket Note: The pulley should be mounted 1.5 cm away from the wall to ensure there is enough space for the motor attachment.

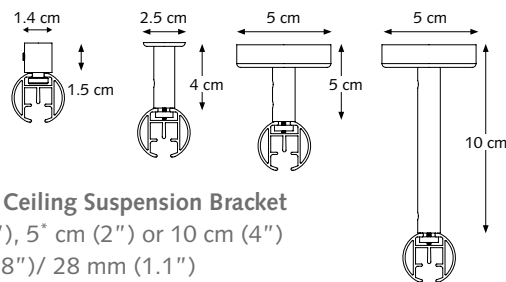
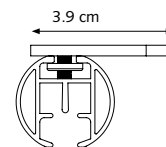

CRS/MRS Ceiling Suspension Bracket

4 cm (1.6"), 5* cm (2") or 10 cm (4")

20 mm (0.8") / 28 mm (1.1")

* = not available in every colour

Check the product overview for colour options

CRS/MRS Wall Bracket, single

12 cm (4.7")

Ø 28 mm (1.1")

16 cm (6.3")

Ø 28 mm (1.1")

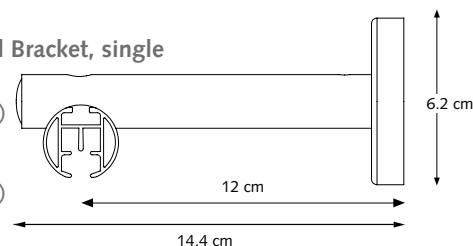

CRS/MRS Wall Bracket, double with 4 cm wall bracket extension 16 cm (6.3") Ø 28 mm (1.1")

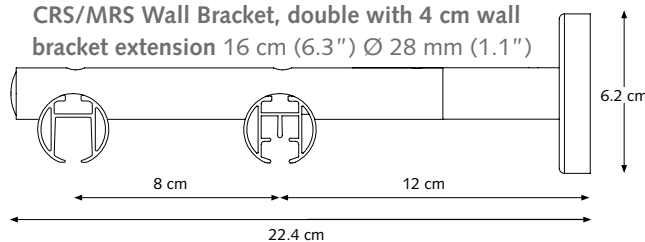

CRS/MRS Wall Bracket, double

20 cm (7.87") Ø 28 mm (1.1")

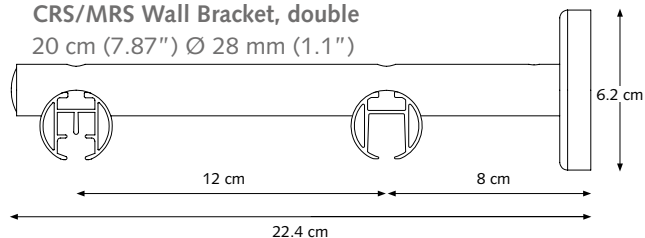

CRS Adjustable Wall Bracket

8 cm (3.1") Ø 20 (0.8") or 28 mm (1.1"), adjustable to 9.5 cm (3.7"). A = 8.9 (3.5") / B = 8 (3.1") < > 9.5 (3.7") / D = 3.75 (1.5") / E = 5.95 cm (2.3")

12 cm (4.7") Ø 20 (0.8") or 28 mm (1.1"), adjustable to 13.5 cm (5.3"). A = 12.9 (5.1") / B = 12 (4.7") < > 13.5 (5.3") / D = 3.75 (1.5") / E = 5.95 cm (2.3")

16 cm (6.3") Ø 20 (0.8") or 28 mm (1.1"), adjustable to 21 cm (8.3"). A = 18.9 (7.4") / B = 7.5 (3.0") < > 10.5 (4.1") / C = 9 (3.5") < > 10.5 (4.1") / D = 3.75 (1.5") / E = 5.95 cm (2.3")

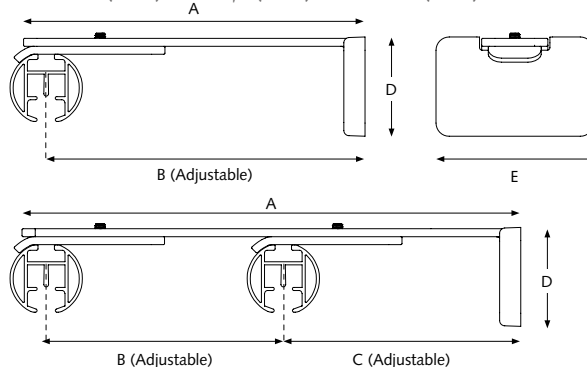

FOREST MOTORISED ROD SYSTEM - MRS®

Our wide range of controls make finding a fit for your home even easier; controlling the curtains by hand, remote or even by building automation system. With the remote you can control the curtains in any position you like. When controlling the motorised curtain system by your smartphone or tablet, you can create and schedule customised room scenes that allow your curtains to operate on their own throughout the day.



REMOTE CONTROL

We offer two different remote controls and a wall switch. These are available in white and black.

- EasyTouch remote control. Operates up to 6 systems, and unused channels can be deactivated.
- Diamond Sense remote control. A 15- or 2-channel remote with an LED display.
- EasyTouch wall switch. A wireless 2-channel wall switch for fixed wall-mounted operation.



APP CONTROL VIA FOREST WIFI-DONGLE

With the Shuttle® Wi-Fi dongle, you can control your motorised curtains with your mobile device by the Forest Connect app or even by voice command with the easy integration in for example Google Home or Amazon Echo without the need for an additional hub or gateway.

APP CONTROL VIA FOREST WIRELESS CONNECTOR

The Forest Wireless Connector provides an easy solution to make Forest motorised curtains 'smart.' When combined with a smart plug, you can effortlessly control the curtains through a mobile app. Controlling the motorised curtains system by your smartphone or tablet, you can create and schedule customized room scenes that allow your curtains to operate on their own throughout the day.



Scan for more info

If you prefer to use the Forest Connect App, you can opt for Forest's smart plug. If you wish to operate your curtains with Apple HomeKit, Amazon Alexa, or Google Assistant, you will need a compatible third-party smart plug that works with these smart home apps. This RF device can also be seamlessly integrated into the most common building management systems, including systems with dry contacts.



BUILDING AUTOMATION / HOTEL CONTROL

The Forest Shuttle® can be connected to any Building Automation system, by relay control.

SMART DEVICE CONNECTIVITY



Configure the right motorised curtain track system in a few steps.

	Shuttle M/L	Shuttle M/L with Z-Wave	Shuttle iOn	Shuttle AC	Shuttle Go	Forest Connect app	Google Home	Apple Homekit	Amazon Alexa	Google Assistant	Apple Siri	Voice control
Forest Wireless Connector One way transmitter to control curtains by third party apps or by Domotics. (433Mhz)	●		●			● ¹	● ¹	● ²	● ¹	● ¹	● ¹	
Forest Wi-Fi Dongle in combination with Forest Connect app	●	●			● ⁵	●	●		●	●	●	
Smartwares Controller in combination with HomeWizard lite app (433 Mhz)	●		●						●			
Homey in combination with Homey app	●	●	●		●		●	●	●	●	●	
FIBARO System in combination with FIBARO Home Center app			●	● ³			●	●	●	●	●	
Samsung SmartThings Hub in combination with Samsung SmartThings app			●				●	●	●	●	●	
230 Volt hard-wired building management system	● ⁴		●									











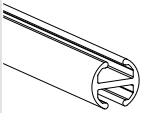
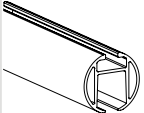
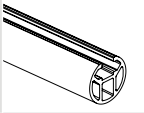
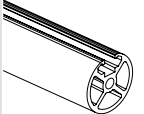
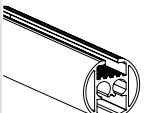
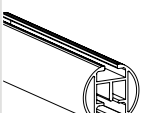

- 1) In combination with Forest smart plug
- 2) In combination with Apple Homekit smart plug
- 3) Only with FIBARO Roller Shutter 3 / Walli Roller Shutter
- 4) In combination with an AC Control Set
- 5) Wi-Fi is included in Shuttle Go. No Wi-Fi Dongle needed to add in the Forest Connect App









FOREST® MRS WORKS WITH



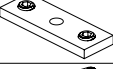

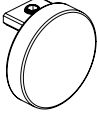
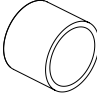
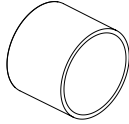
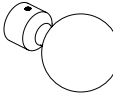
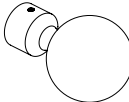

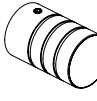

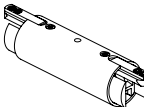

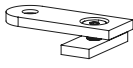

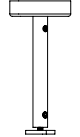
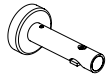

* Only works with actor.

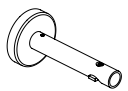

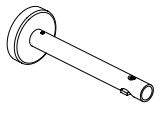
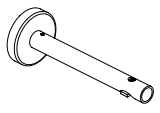
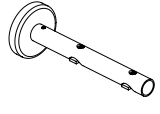

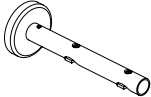
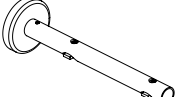
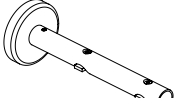
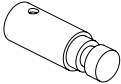
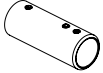

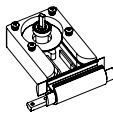
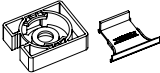

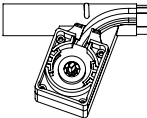
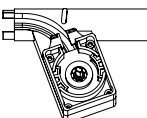

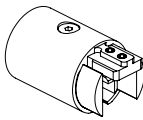
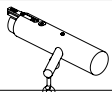
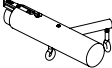







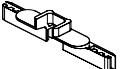

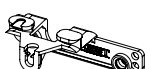
MRS® is compatible with many other Building Automation systems, thanks to its modular construction. A competitive advantage over other motorised drapery systems in the world!

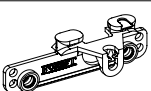
CRS 20 mm	CRS 28 mm	CRS DECO 20	CRS DECO 28	CRS CORDED	MRS	ARTICLE	PACKING UNIT		ART.NR
●						 CRS CHANNEL ROD Ø 20 MM (0.8") Extruded aluminium, powder coated	5.80 mtr/tube	white-pc gold-an inox-an stone grey-pc taupe-pc black-pc antique-pc anthracite-pc chrome	5801201580-PC 5801202580 5801203580 5801203580-SG 5801204580-PC 5801206580-PC 5801209580-PC 5801205580-PC 5801207580
	●					 CRS CHANNEL ROD Ø 28 MM (1.1") Extruded aluminium, powder coated	5.80 mtr/tube	white-pc gold-an inox-an stone grey-pc black-pc antique-pc anthracite-pc taupe-pc chrome	5801281580-PC 5801282580 5801283580 5801283580-SG 5801286580-PC 5801289580-PC 5801285580-PC 5801284580-PC 5801287580
		●				 CRS DECO ROD Ø 20 MM (0.8") Extruded aluminium, powder coated	5.80 mtr/tube	inox-an antique-pc taupe-pc anthracite-pc chrome	5841203580 5841209580-PC 5841204580-PC 5841205580-PC 5841207580
			●			 CRS DECO ROD Ø28 MM (1.1") Extruded aluminium, powder coated incl. inlay strip	5.80 mtr/tube	inox-an inox-pc antique-pc taupe-pc anthracite-pc chrome	5841283580 5841283580-PC 5841289580-PC 5841284580-PC 5841285580-PC 5841287580
				●		 CRS CHANNEL ROD CORDED Ø 28 MM (1.1") Extruded aluminium, powder coated incl. inlay strip	5.80 mtr/tube	white-pc gold-an inox-an stone grey-pc antique-pc taupe-pc anthracite-pc chrome	5811281580-PC 5811282580 5811283580 5811283580-SG 5811289580-PC 5811284580-PC 5811286580-PC 5701287520
					●	 MRS MOTORISED ROD Ø28 MM (1.1") Extruded aluminium, powder coated	5.80 mtr/tube	white-pc gold-an inox-an stone grey-pc antique-pc taupe-pc anthracite-pc chrome	5701281580-PC 5701282580 5701283580 5701283580-SG 5701289580-PC 5701284580-PC 5701286580-PC 5701287520
●	●			●		 CRS CARRIER ROUND	500/box	white grey black	5810101000 5810103000 5810106000
					●	 MRS CARRIER ROUND	500/box	white grey black	5710101000 5710103000 5710106000
	●					 CS BALL BEARING (SMALL) carrier 16 mm for 28 mm CRS manual	100/box	white black	2512000016 2512006016
	●					 CONTRACT ROLLER CARRIER For a silent and smoothly operation with heavier curtains. Designed for use with butterfly pleats.	100/box	white black	4831001000 4831006000
		●				 CRS DECO CURTAIN RING FOR 20 MM	50/box	inox-an taupe-pc anthracite-pc chrome antique-pc	5841203000 5841204000-PC 5841205000-PC 5841207000 5841209000-PC
			●			 CRS DECO CURTAIN RING FOR 28 MM	50/box	inox-an taupe-pc anthracite-pc chrome antique-pc	5841283000 5841284000-PC 5841285000-PC 5841287000 5841289000-PC
●				●		 CRS METAL ENDSTOP WITH SCREW for 20 mm (0.8")	2/box		5816101000
	●			●		 CRS METAL ENDSTOP WITH SCREW for 28 mm (1.1")	100/box		5816101001
●						 CRS METAL ENDSTOP WITH SCREW-EYE for 20 mm (0.8")	100/box		5816102000
	●					 CRS METAL ENDSTOP WITH SCREW-EYE for 28 mm (1.1") long	100/box		5816102001
●						 CRS METAL ENDSTOP WITH SCREW-EYE for 20 mm (1.1") long	100/box		5816101000

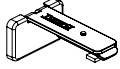
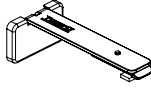
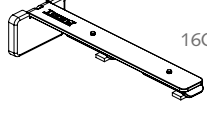
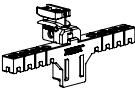
CRS 20 mm	CRS 28 mm	CRS DECO 20	CRS DECO 28	CRS CORDED	MRS	ARTICLE	PACKING UNIT		ART.NR
●	●				●	 END STOP UNIVERSAL METAL	100/box	white matt stonegrey black matt	8880001000-V2-M 8880003000 8880006000-V2-M
●	●			●		 CRS RAIL CONNECTOR (6 CM)	25/box		5815200006
		●	●		●	 CRS DECO / MRS / FMS PLUS TRACK CONNECTOR (20/28 MM)	25/box		5815200005
●	●	●	●	●		 CRS CORNER CONNECTOR (5 CM)	10/box		5815200007
●		●				 CRS FINIAL SHORT ENDCAP Ø 20 MM	10/box	white-pc gold-an inox-an stone grey-pc taupe-pc anthracite-pc black-pc chrome antique-pc	5816101220-PC 5816102220 5816103220 5816103220-SG 5816104220-PC 5816105220-PC 5816106220-PC 5816107220 5816109220-PC
	●		●			 CRS FINIAL SHORT ENDCAP Ø 28 MM	10/box	white-pc inox-an stone grey-pc taupe-pc anthracite-pc black-pc antique-pc	5816101228-PC 5816103228 5816103228-SG 5816104228-PC 5816105228-PC 5816106228-PC 5816109228-PC
●		●				 CRS FINIAL Ø 20 MM	10/box	white-pc gold-an inox-an stone grey-pc black-pc antique-pc taupe-pc anthracite-pc chrome	5816101020-PC 5816102020 5816103020 5816103020-SG 5816106020-PC 5816109020-PC 5816104020-PC 5816105020-PC 5816107020
	●		●		●	 CRS FINIAL Ø 28 MM	10/box	white-pc gold-an inox-an stone grey-pc black-pc antique-pc taupe-pc anthracite-pc chrome	5816101028-PC 5816102028 5816103028 5816103028-SG 5816106028-PC 5816109028-PC 5816104028-PC 5816105028-PC 5816107028
	●		●		●	 CRS/MRS FINIAL ROUND 60 MM 28 mm	2/box	white-pc gold-an inox-an black-pc antique-pc taupe-pc anthracite-pc chrome	5716101100-PC 5716102100 5716103100 5716106100-PC 5716109100-PC 5716104100-PC 5716105100-PC 5716107100
	●		●		●	 CRS/MRS FINIAL ROUND 70 MM 28 mm	2/box	gold-an inox-an inox-pc antique-pc taupe-pc anthracite-pc chrome	5716102000 5716103000 5716103000-PC 5716109000-PC 5716104000-PC 5716105000-PC 5716107000
	●		●		●	 CRS FINIAL WITH 3 GROOVES 20 mm	2/box	inox-an anthracite-pc chrome	5816103120 5816105120-PC 5816107220
●		●				 CRS/MRS FINIAL WITH 3 GROOVES 28 mm	2/box	white-pc gold-an inox-an black-pc antique-pc taupe-pc anthracite-pc chrome	5816101128-PC 5816102128 5816103128 5816106128-PC 5816109128-PC 5816104128-PC 5816105128-PC 5816107128
				●		 CRS CORDED END PULLEY complete	2/box	white-pc gold-an inox-an stone grey-pc antique-pc taupe-pc anthracite-pc	6130201001-PC 6130202001 6130203001 6130203001-SG 6130209001-PC 6130204001-PC 6130206001-PC
				●		 CRS CORDED CENTRE PULLEY complete	2/box	white-pc inox-an antique-pc taupe-pc anthracite-pc	6130251001-PC 6130253001 6130259001-PC 6130254001-PC 6130256001-PC

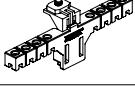









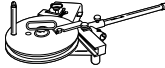

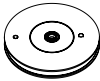

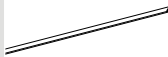
CRS 20 mm	CRS 28 mm	CRS DECO 20	CRS DECO 28	CRS CORDED	MRS	ARTICLE	PACKING UNIT		ART.NR
●	●			●	●	 CRS CEILING BRACKET LONG Ø 28 MM	100/box	white-pc grey-pc stone grey-pc anthracite-pc black-pc antique-pc	5818003101-LA 5818003103-LA 5818009103-SG 5818009103-LA 5818006103-LA 5818009104-LA
●	●			●	●	 CRS CEILING BRACKET 1,5 CM	4/box	white-pc inox-an stone grey-pc taupe-pc antique-pc antique-pc	5818212028-PC 5818232028 5818232028-SG 5818242028-PC 5818252028-PC 5818292028-PC
●	●	●	●	●	●	 CRS CEILING SUSPENSION BRACKET 4 CM (1.57'') Ø 20/28 mm	4/box	white-pc gold-an inox-an taupe-pc black-pc antique-pc anthracite-pc chrome	5818112000-PC 5818122000 5818132000 5818142000-PC 5818162000-PC 5818192000-PC 5818152000-PC 5818172000
●	●	●	●	●	●	 CRS CEILING SUSPENSION BRACKET 5 CM (1.96'') Ø 20/28 mm	2/box	white-pc gold-an inox-an inox-pc antique-pc	5818112028-PC 5818122028 5818132028 5818132028-PC 5818192028-PC
●	●	●	●	●	●	 CRS CEILING SUSPENSION BRACKET 10 CM (3.93'') Ø 20/28 mm	2/box	white-pc gold-an inox-an black-pc antique-pc anthracite-pc	5818012028 5818022028 5818032028 5818062028-PC 5818092028-PC 5818052028-PC
●		●				 CRS WALL BRACKET SINGLE 8 CM (3.15'') Ø 20 mm	2/box	white-pc gold-an inox-an stone grey-pc black-pc antique-pc anthracite-pc chrome	5820080120-PC 5820080220 5820080320 5820080320-SG 5820080620-PC 5820080920-PC 5820080520-PC 5820080720
	●		●	●		 CRS WALL BRACKET SINGLE 8 CM (3.15'') Ø 28 mm	2/box	white-pc gold-an inox-an stone grey-pc black-pc antique-pc taupe-pc anthracite-pc chrome	5820080128-PC 5820080228 5820080328 5820080328-SG 5820080628-PC 5820080928-PC 5820080428-PC 5820080528-PC 5820080728
●		●				 CRS WALL BRACKET SINGLE 12 CM (4.72'') Ø 20 mm	2/box	white-pc gold-an inox-an black-pc antique-pc anthracite-pc chrome	5820120120-PC 5820120220 5820120320 5820120620-PC 5820120920-PC 5820120520-PC 5820120720
	●		●	●	●	 CRS WALL BRACKET SINGLE 12 CM (4.72'') Ø 28 mm	2/box	white-pc gold-an inox-an stone grey-pc black-pc antique-pc taupe-pc anthracite-pc chrome	5820120128-PC 5820120228 5820120328 5820120328-SG 5820120628-PC 5820120928-PC 5820120428-PC 5820120528-PC 5820120728
●		●				 CRS WALL BRACKET SINGLE 16 CM (6.29'') Ø 20 mm	2/box	white-pc gold-an inox-an black-pc antique-pc	5820160120-PC 5820160220 5820160320 5820160620-PC 5820160920-PC
	●		●	●	●	 CRS WALL BRACKET SINGLE 16 CM (6.29'') Ø 28 mm	2/box	white-pc gold-an inox-an stone grey-pc black-pc antique-pc taupe-pc anthracite-pc	5820160128-PC 5820160228 5820160328 5820160328-SG 5820160628-PC 5820160928-PC 5820160428-PC 5820160528-PC
●		●				 CRS WALL BRACKET DOUBLE 16 CM (6.29'') Ø 20 mm	2/box	white-pc gold-an inox-an stone grey-pc black-pc antique-pc chrome	5822160120-PC 5822160220 5822160320 5822160320-SG 5822160620-PC 5822160920-PC 5822160720

CRS 20 mm	CRS 28 mm	CRS DECO 20	CRS DECO 28	CRS CORDED	MRS	ARTICLE	PACKING UNIT		ART.NR
	●		●	●	●	 CRS WALL BRACKET DOUBLE 16 CM (6.29") Ø 28 mm	2/box	white-pc gold-an inox-an stone grey-pc black-pc antique-pc taupe-pc anthracite-pc	5822160128-PC 5822160228 5822160328 5822160328-SG 5822160628-PC 5822160928-PC 5822160428-PC 5822160528-PC
	●		●		●	 CRS WALL BRACKET DOUBLE 20 CM (7.87") Ø 28 mm	2/box	white-pc gold-an inox-an black-pc antique-pc taupe-pc anthracite-pc chrome	5822200128-PC 5822200228 5822200328 5822200628-PC 5822200928-PC 5822200428-PC 5822200528-PC 5822200728
●	●		●			 CRS WALL BRACKET DOUBLE 16 CM (6.29") Ø 20/28 mm	2/box	white-pc gold-an inox-an black-pc antique-pc	5822012028-PC 5822022028 5822032028 5822036028-PC 5822039028-PC
●	●	●	●	●	●	 CRS WALL BRACKET EXTENSION 4 CM	10/box	white-pc inox-an stone grey-pc black-pc taupe-pc antique-pc anthracite-pc	5815201030-PC 5815203030 5815203030-SG 5815206030-PC 5815204030-PC 5815209030-PC 5815205030-PC
●	●	●	●	●	●	 CRS ADJUSTABLE WALL BRACKET EXTENSION Adjustable 2-4 cm	10/box	white-pc gold-an inox-an stone grey-pc taupe-pc anthracite-pc black-pc antique-pc	5815101070-PC 5815102070 5815103070 5815103070-SG 5815104070-PC 5815105070-PC 5815106070-PC 5815109070-PC
●		●				 CRS INSIDE WALL BRACKET Ø 20 MM	10/box	white-pc gold-an inox-an stone grey-pc black-pc antique-pc	5817101020-PC 5817102020 5817103020 5817103020-SG 5817106020-PC 5817109020-PC
	●		●		●	 CRS INSIDE WALL BRACKET Ø 28 MM	10/box	white-pc gold-an inox-an stone grey-pc black-pc antique-pc taupe-pc anthracite-pc chrome	5817101028-PC 5817102028 5817103028 5817103028-SG 5817106028-PC 5817109028-PC 5817104028-PC 5817105028-PC 5817107028
					●	 MRS MOTOR PULLEY UNIVERSAL RENEWED!	1/box	white-pc gold-an stone grey-pc inox-an antique-pc taupe-pc anthracite-pc	5740101000-PC 5740102000-AN 5740103000-PC 5740108000-AN 5740109000-PC 5740104000-PC 5740105000-PC
					●	 MRS MOTOR PULLEY UNIVERSAL CAP SET RENEWED!	1/box	white grey black	5740101010 5740103010 5740106010
					●	 MRS MOTOR PULLEY UNIVERSAL FINIAL RENEWED!	1/box	white-pc gold-an stone grey-pc inox-an antique-pc taupe-pc anthracite-pc	5740111000-PC 5740112000-AN 5740113000-PC 5740118000-AN 5740119000-PC 5740114000-PC 5740115000-PC
					●	 MRS MOTOR PULLEY LEFT	1/box	chrome	5730107000
					●	 MRS MOTOR PULLEY RIGHT	1/box	chrome	5730207000

CRS 20 mm	CRS 28 mm	CRS DECO 20	CRS DECO 28	CRS CORDED	MRS	ARTICLE	PACKING UNIT		ART.NR
					●	 <p>MRS RETURN PULLEY UNIVERSAL RENEWED!</p>	1/box	white-pc gold-an stone grey-pc inox-an antique-pc taupe-pc anthracite-pc	5740121000-PC 5740122000-AN 5740123000-PC 5740128000-AN 5740129000-PC 5740124000-PC 5740125000-PC
					●	 <p>MRS RETURN PULLEY LEFT</p>	1/box	chrome	5730117000
					●	 <p>MRS RETURN PULLEY RIGHT</p>	1/box	chrome	5730127000
				●		 <p>TRAVERSE CORD Polyester drapery cord designed for strong smooth slide, Ø 3.5 mm (0,14"), 16 ply. Suitable for CKS/CCS/CRS/DS-XL Corded</p>	250 mtr/roll	white grey black	1030401000 1030403000 1030406000
				●		 <p>CCS DOUBLE CORD CONNECTOR</p>	20/box	white grey black	3030301010 3030303010 3030306010
				●		 <p>ASSEMBLY TOOL FOR CKS/CCS/CRS CORD CONNECTOR</p>	Piece		9510000027
				●		 <p>CORD/CHAIN WEIGHT DESIGN</p>	10/box	white black grey	3030701000 3030706000 3030703000
				●		 <p>CKS / CCS TENSION PULLEY</p>	25/box		1030501000
				●		 <p>BS CORD / CHAIN WALL MOUNT SAFETY BOX SINGLE</p>	25/box		3645702000
				●		 <p>FMS TRANSPORT BELT</p>	100 Mtr/ roll		5105501000
				●		 <p>EASYFOLD MRS BELT CONNECTOR</p>	 25/box		4805711500
●	●			●	●	 <p>EASYFOLD PLASTIC MASTER UNDERLAP</p>	 25/box	white grey black transparent	4815201010 4815203010 4815206010 4815201000
●	●			●	●	 <p>EASYFOLD PLASTIC MASTER STRAIGHT/OVERLAP</p>	 25/box	white grey black transparent	4815101010 4815103010 4815106010 4815101000
●	●	●	●	●	●	 <p>CRS ADJUSTABLE WALL BRACKET 8CM INCL. COVER</p>	2/box	white-pc stone grey-pc taupe-pc anthracite-pc antique-pc	5830001080 5830003080-SG 5830004080 5830005080 5830009080
●	●	●	●	●	●	 <p>12CM INCL. COVER</p>		white-pc stone grey-pc taupe-pc anthracite-pc antique-pc	5830001120 5830003120-SG 5830004120 5830005120 5830009120
●	●	●	●	●	●	 <p>16CM DOUBLE INCL. COVER</p>		white-pc stone grey-pc taupe-pc anthracite-pc antique-pc	5830001160 5830003160-SG 5830004160 5830005160 5830009160
				●	●	 <p>WAVE ADJUSTABLE MASTER CARRIER For use with wave pleat curtains (Easyflex)</p>	 25/box	white black	4813001050 4813006050
	●			●	●	 <p>WAVE ADJUSTABLE ENDSTOP For use with wave pleat curtains (FES). Height adjustable and blocks detachable for the correct wave pleat depth</p>	 25/box	white black	4816001001 4816006001
				●	●	 <p>WAVE ADJUSTABLE HOOK FOR MOTOR For use with wave pleat curtains (Easyflex) (only suitable for MRS motor pulley left & right)</p>	 25/box	white black	4813001010 4813006010

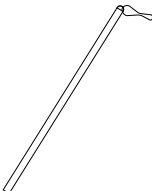
GO TO THE FES BROCHURE FOR OTHER FES (WAVE) ITEMS, SUCH AS CARRIERS, TAPE, AND HOOKS.

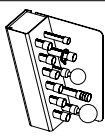

CRS 20 mm	CRS 28 mm	CRS DECO 20	CRS DECO 28	CRS CORDED	MRS	ARTICLE	PACKING UNIT	ART.NR	
●	●					 CONTRACT BENDING TOOL, for Ø20 and Ø 28 mm (1.1") CRS	1/each	256000000	
●						 CRS CONTRACT BENDING WHEEL ALL-IN Ø 20 cm (8"), for Ø 20 mm (0,8") CRS incl. strips	1/each	5860200020	
	●					 CRS BENDING WHEEL Ø 40 cm (16"), for Ø 28 mm (1.1") CRS incl.strips	1/each	5860000028	
●						 CRS BENDING STRIPS Ø 20 mm (0.8"), 60 cm (23.6")	1/each	5860100020	
	●					 CRS BENDING STRIPS, Ø 28 mm (1.1"), 60 cm (23.6")	1/each	5860100028	
●						 CRS Bending Strips, Ø 20 mm (0.8"), 7 m (275")	1/each	5860700020	
	●					 CRS BENDING STRIPS, Ø 28 mm (1.1"), 7 m (275")	1/each	5860700028	
	●					 WORKTABLE BENDING TOOL Stand for contract bending tool 28 mm (1,1")	1/each	2560800000	
●	●					 ELECTRIC POWERED BENDER Available in 230V or 115V	1/each	1060500000	
●	●					 SET CRS BENDING WHEELS Ø 20/28 mm (0,8/1,1")	1/set	5860702028	
●	●	●	●	●	●	 FOREST LUBRICANT SPRAY To lubricate components during assembly.		510901000	
●	●	●	●			 DRAW STICK FIBERGLASS DRAW STICK TRANSPARENT DRAW STICK ALUMINIUM WHITE DRAW STICK ALUMINIUM GREY DRAW STICK ALUMINIUM BLACK DRAW STICK ALUMINIUM ANTIQUE	100/box 50/box 50/box 50/box 50/box 50/box	92 cm 122 cm 152 cm 202 cm 92 cm 122 cm 152 cm 202 cm 92 cm 122 cm 152 cm 92 cm 122 cm 152 cm 92 cm 122 cm 152 cm	1065101092 1065101122 1065101152 1065001202 1065102092 1065102122 1065102152 1065111092 1065111122 1065111152 1065111202 1065113092 1065113122 1065113152 1065116092 1065116122 1065116152 1065119092 1065119122 1065119152
●	●	●	●	●	●	 FOREST ROD COLOUR COLLECTION BOX	1/each	9905000000	
●	●	●	●	●	●	 DECORATIVE ROD DISPLAY including rods and colour sampler	1/set	9902000001	
●	●	●	●	●	●	 FOREST ROD DEMO FLIGHTCASE The Rod Demo Case provides a comprehensive overview of our rod assortment, including CRS 20mm, CRS 28mm, CRS Deco 20mm, CRS Deco 28mm, CRS corded, and MRS.	1/each	9904000000	



Scan the QR code for
Shuttle motors and
operating modes.